

Article number: 2310306921

Description: E+G Levelling element  
LV.A-125-ACV-M20x136

## Measures

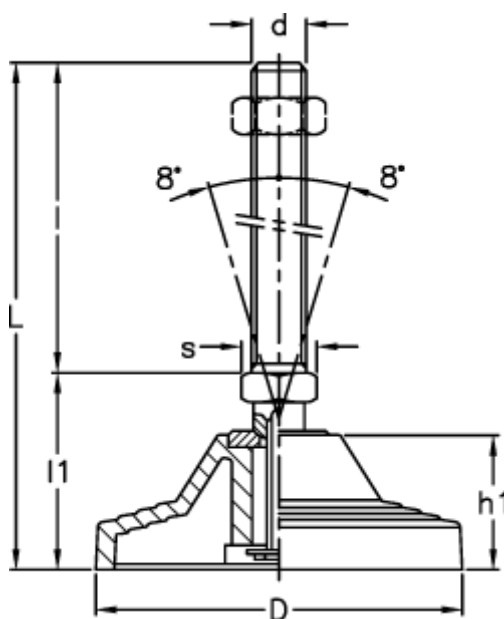

d	= M20
D	= 125
h	= 45
l	= 136
L	= 200
l1	= 64
Max load (N)	= 40000
s	= 24